

MODEL NO : OBO-04KP-0B-0N6

Features:Conformity RoHS Directive(2002/95/EC) Requests.

1. ELECTRICAL CHARACTERISTICS

Test Condition:(Vs=4.5 V,RL=2.2KΩ,Ta=20±2°C,R.H.=65±5°C)

Directivity : Omnidirectional

No	Parameter	Symbol	Condition	Limit			Unit
				Min	Center	Max	
1.1	Sensitivity	S	F=1KHz,S.P.L.=1Pa 0dB=1V/Pa	-39	-36	-33	dB
1.2	Output Impedance	Zout	F=1KHz			2.2	KΩ
1.3	Current Consumption	IDss	VS=4.5V, L=2.2KΩ			500	μA
1.4	Signal to Noise Ratio	S/N	S:(F=1KHz,S.P.L.=1Pa) N:(A-Weighted Curve)	60			dB
1.5	Decreasing Voltage	ΔS-VS	VS=1.5V to 3.0V			-3	dB

1.6 Typical Frequency Response Curve Limit

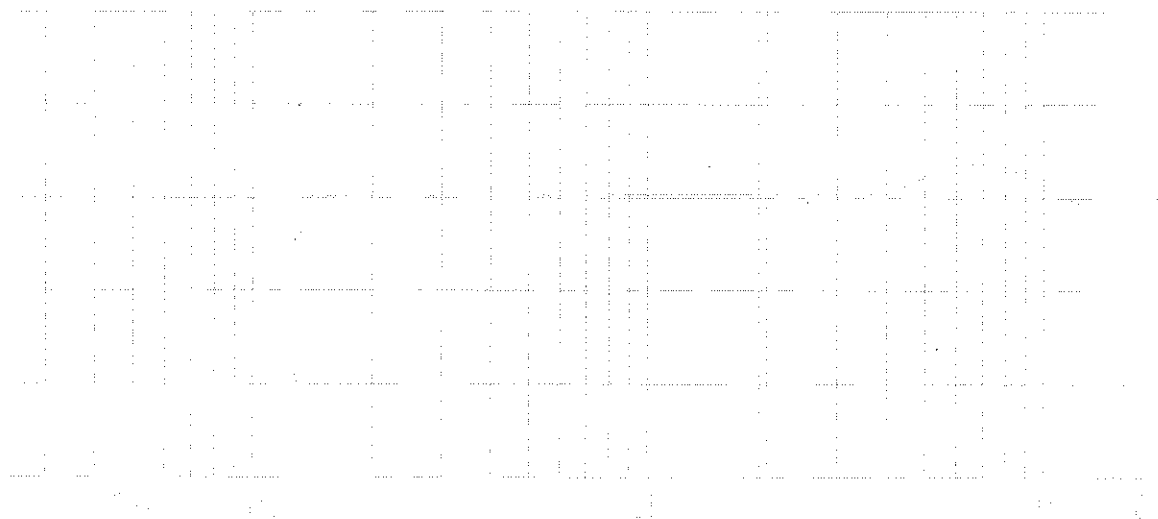

◎Frequency: 50~16,000Hz

◎Max Operatint Voltage: 10V

2. MEASUREMENT CIRCUIT

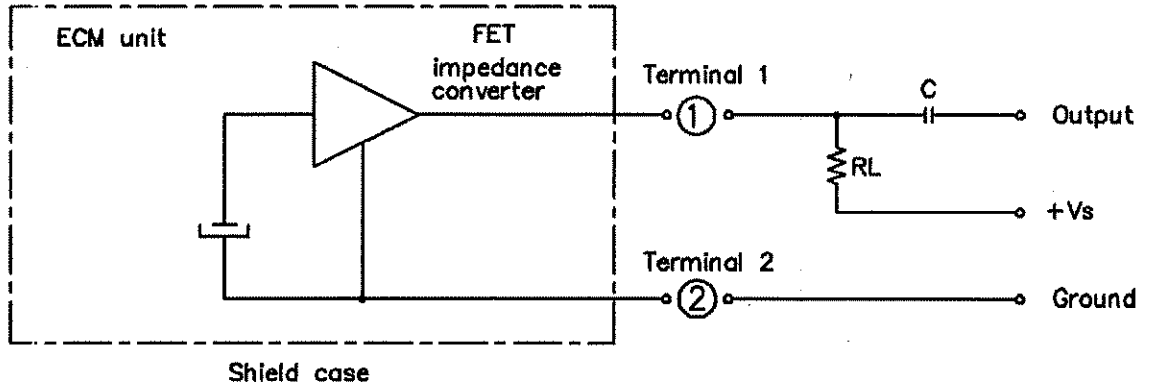

3. MEASUREMENT METHOD

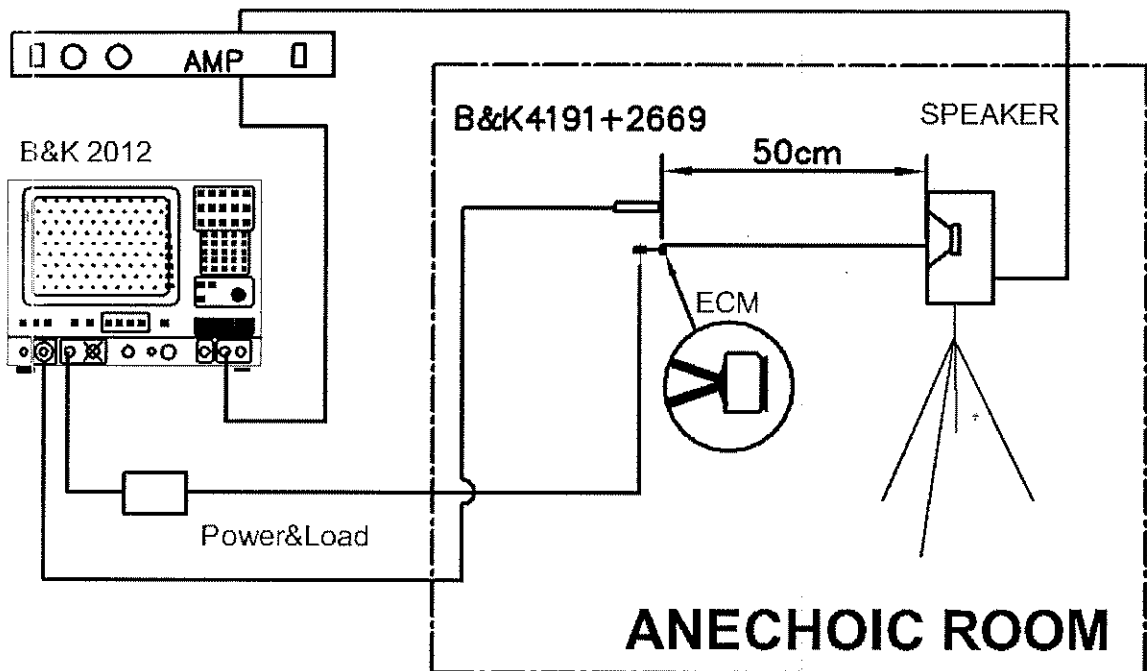

4. ASS'Y DRAWING

4.1 Soldering Standard : $330\pm 5^{\circ}\text{C}$ / Max. 2 seconds

4.2 Mechanical Layout and Dimensions :

Unit:mm

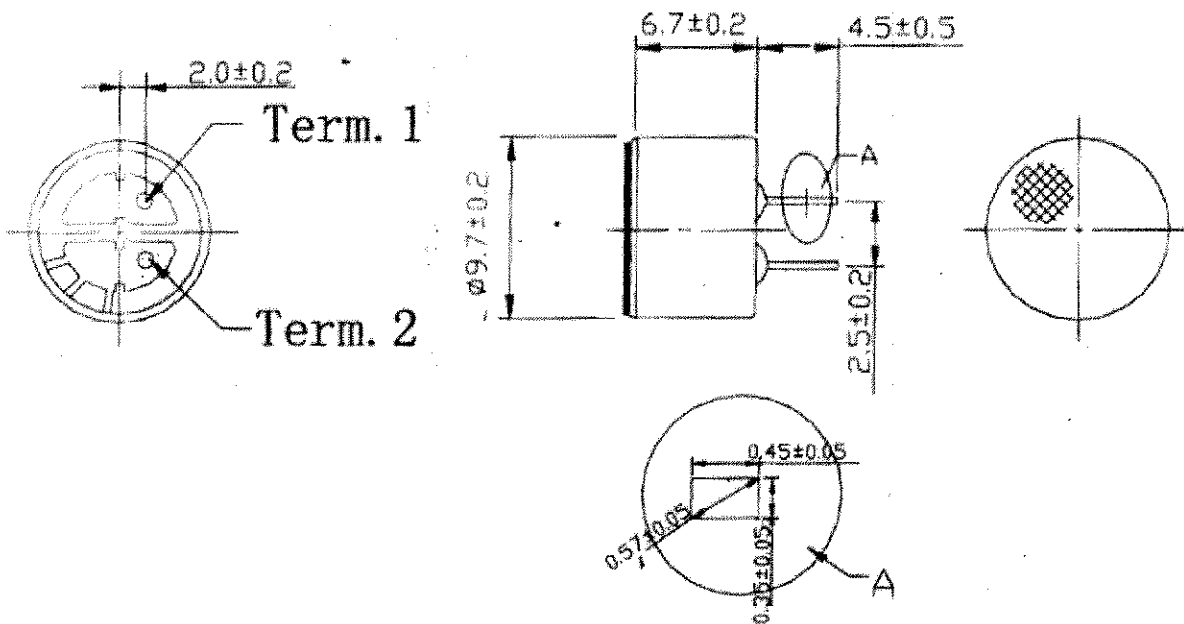

5. TEMPERATURE CONDITIONS

5.1 Operating Temperature Range: $-20^{\circ}\text{C} \sim +70^{\circ}\text{C}$

5.2 Storage Temperature Range: $-20^{\circ}\text{C} \sim +70^{\circ}\text{C}$

6. RELIABILITY TEST

Vibration Test	To be no interference in operation after vibrations, 10Hz to 55Hz for 1 minute full amplitude 1.5mm, for 2 hours at 3 axes .
Drop Test	The microphone unit without packaged must be subjected to each 3one time from 1 drops at 3 axes,the height of 1 meter to 20 mm thick wooden board.
Temperature	(a) After exposure at $+70^{\circ}\text{C}$ for 72 hours, sensitivity to be within $\pm 3\text{dB}$ from initial sensitivity. (b) After exposure at -25°C for 72 hours, sensitivity to be within $\pm 3\text{dB}$ from initial sensitivity. (The measurement to be done after 6 hours of conditioning at 25°C)
Humidity Test	After exposure at $+60^{\circ}\text{C}$ and 90%~95% relative humidity for 240hours. sensitivity to be within $\pm 3\text{dB}$ from initial sensitivity. (The measurement to be done after 6 hours of conditioning at 25°C)
Temperature Cycle Test	After exposure at $+70^{\circ}\text{C}$ for 1 hr, from $+70^{\circ}\text{C}$ to $+25^{\circ}\text{C}$ for 0.5 hr ,at $+25^{\circ}\text{C}$ for 1 hr, from $+25^{\circ}\text{C}$ to -20°C for 0.5 hr ,at -20°C for 1 hr, from -20°C to $+25^{\circ}\text{C}$ for 0.5 hr , after 10 cycles , sensitivity to be within $\pm 3\text{dB}$ from initial sensitivity. (The measurement to be done after 6 hours of conditioning at 25°C)

7. CONCEPT OF UNIT

The difference between concept of unit "Pascal" and the one of unit can be explained as follows. in calibrating the sensitivity of ECMS. the sensitivity is manifested differently according as the unitis "Pascal" or " μbar ". That is the sensitivity will be increased by 20dB in the usage of unit "Pascal". Example : $-65\text{dB}(0\text{dB}=1\text{V}/\mu\text{bar})=-45\text{dB}(0\text{dB}=1\text{V}/\text{Pa})$

8. PACKAGING

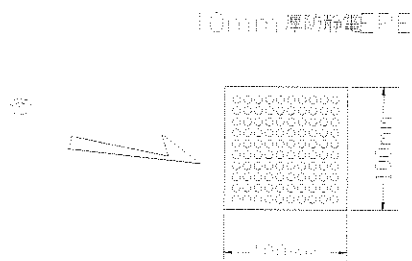

LOAD IN

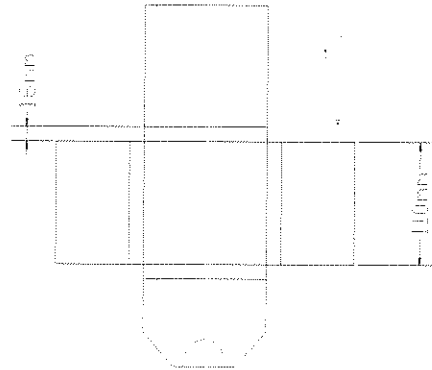

100 pcs / 1 CARDBOX

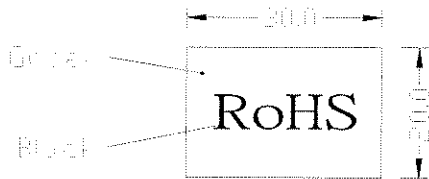

RoHS Tape
(20*10 mm)

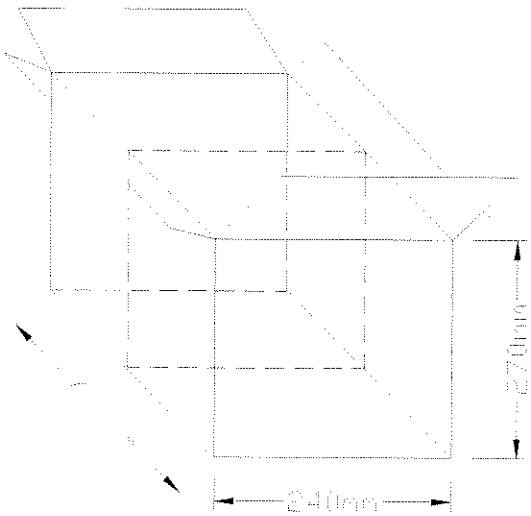
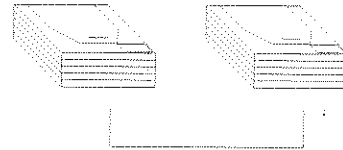

2 MIDDLE BOXES / PER
CARTON (12000 pcs)
(IMPORTED CARTON MATERIAL)

LOAD IN

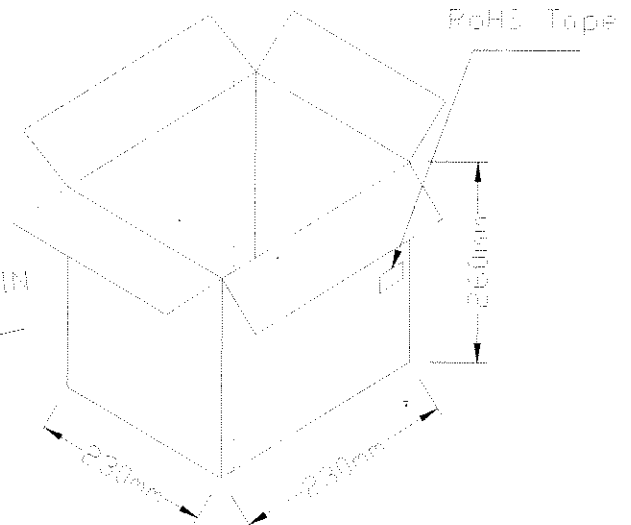

60 SMALLBOXES / PER
MIDDLE OUTSIDE BOX (6000 pcs)
(IMPORTED CARTON MATERIAL)