



MODEL NO : OBO-11250WA

Features : External drive ※2

Conformity RoHS Directive(2002/95/EC) Requests.

### 1. General Specifications:

Items	Spec.
Sound Pressure Level	80dB min. at 5.0KHz/9Vp-p Square wave/10cm
Capacitance	9,500pF ± 30% at 120Hz
Current Consumption	3mA max. at 5.0KHz/9Vp-p Square Wave
Allowable Input Voltage	15Vp-p max.
Case Material	ABS
Operating Temp. Range	-20°C to +60°C
Storage Temp. Range	-30°C to +70°C
Weight	0.3gms

### 2. Measuring Method:

#### 2.1 S.P.L Measuring Circuit

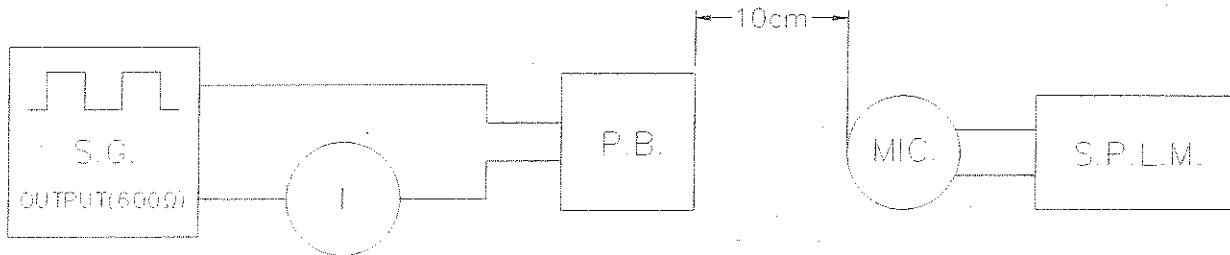

S.G. : GAG-808G Audio Ggenerator or Equivalent

S.P.L.M. : Sound Pressure Level Meter IEC651 TYPE2

I. : GDM-8145 Multimeter or Equivalent

P.B. : Piezoelectric Buzzer

Note: please pay attention never to be applied DC voltage to piezo sounder.

#### 2.2 Measuring condition

Part shall be measured under a condition (Temperature: +5°C to +35°C, Humidity: 45% to 85%R.H.) unless the standard condition (Temperature: +25±3°C, Humidity: 60±10%R.H.) is regulated to measure.

OBO PRO.2 INC.  
2011 FEB 28  
文件发行章

### 3. Mechanical Layout and Dimensions:

#### 3.1 Dimendions

Tolerance:  $\pm 0.3$  Unit: mm

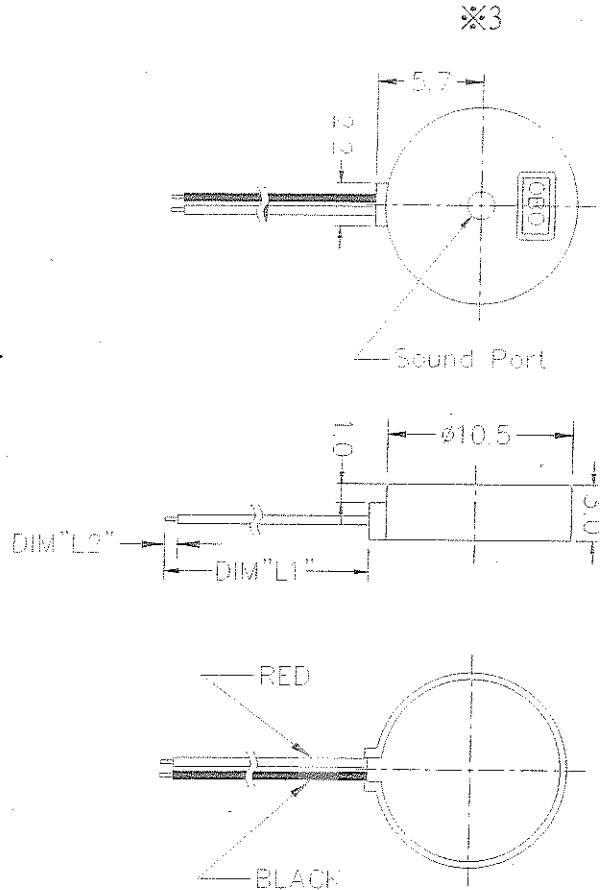

Customer	Lead Wire	DIM "L1"	DIM "L2"
Standard	UL1571#32	25 $\pm$ 3	1.5 $\pm$ 0.5

#### 3.2. Environment-related substances to be controlled.

© Piezoelectric Ceramic Disc.

RoHs Annex:

Application of lead, mercury, cadmium and hexavalent chromium, which are exempted from the requirement of article 4(1).

\* Lead in electronic ceramic parts.(e.g. piezoelectronic devices)

### 4.Soldering Condition:

#### 4.1 Hand Soldering

Iron Tip Temperature	Soldering time
+380°C Max.	Duration 3 seconds Max.

5. Reliability Test Conditions :

5.1 Mechanical Sequence

	Test Items	Test Conditions	Performance Requirements
a	Vibration	10 ~ 55 -10Hz, Sinewave sweep 15 minutes. X,Y,Z 3 direction 2 hours each. Total 6 hours	The measured values shall meet Remarks 1,2
b	Free Drop Test	Free fall from a height of 100 cm. Onto the 10 mm thick hardwood board. 9 times, any directions	
c	Terminal Strength Pushing	The force 10 seconds of 0.5Kg is applied to each terminal in axial direction.	

5.2 Environmental Sequence

	Test Items	Test Conditions	Performance Requirements
a	Humidity Test	+60±2°C, 90 ~ 95%RH, 96 hrs.	The measured values shall meet Remarks 1,2
b	High Temp. Storage	+70±2°C, 96 hrs.	
c	Low Temp. Storage	-30±2°C, 96 hrs.	
d	Thermal Shock	-30±2°C(30min.) - +70±2°C(30min.) 50 cycle. Transfer Time : 10 minutes	

5.3 Operating Life Sequence

	Test Items	Test Conditions	Performance Requirements
a	Ordinary Temp. Operating Test	Continuous sound generation for 96 hrs. at 5.0KHz/9Vp-p and +25±10°C	The measured values shall meet Remarks 1,2
b	High Temperature Operating Test	Continuous sound generation for 96 hrs. at 5.0KHz/9Vp-p and +60±2°C	
c	Low Temperature Operating Test	Continuous sound generation for 96 hrs. at 5.0KHz/9Vp-p and -20±2°C	

Remarks:

- 1.Sounder shall be measured after being placed in natural condition for 4 hours.
- 2.After the test the part shall meet specifications without any degradation in appearance and performance except SPL: Initial±10dB and Capacitance: initial±20%

### 6. Packing Information :

OBO PRO.2 INC.

MODEL NO.	
LOT NO.	
QUANTITY	
DATE	

100pcs / Label  
(80\*50\*0.08mm)



Buzzer

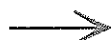

100pcs/ PE Bag  
(220\*155\*0.05mm)

RoHS Tape

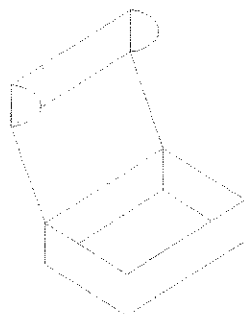

10 PE Bag(1,000pcs) / Inside box  
(218\*152\*61mm)

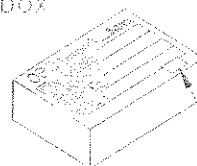

RoHS Tape

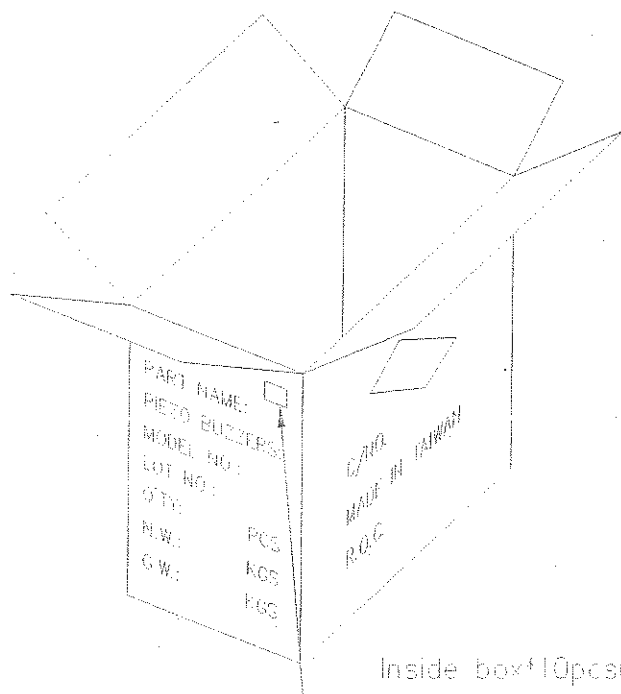

Inside box\*10pcs(10,000pcs) / Carton

RoHS Tape

0.96 # (352\*235\*556mm)

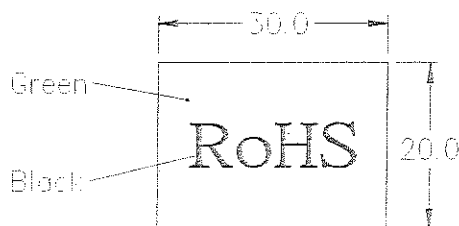

RoHS Tape  
(30\*20 mm)