

Customer Information Sheet

DRAWING No.: M80-4C11642F2-03-325-01-307

SHEET 2 OF 2

IF IN DOUBT - ASK

©

NOT TO SCALE

THIRD ANGLE PROJECTION

ALL DIMENSIONS IN mm

SPECIFICATIONS:

MATERIAL:

MOULDING: GLASS FILLED PPS, UL94V-0, BLACK

SIGNAL CONTACT:

CLIP = BERYLLIUM COPPER

SHELL = BRASS

POWER CONTACT:

BODY = COPPER ALLOY

LATCHING COLLAR = BERYLLIUM COPPER

COAX CONTACT:

BODY, SLEEVE = COPPER ALLOY

INNER CONTACT, LATCHING COLLAR = BERYLLIUM COPPER

INSULATOR = PTFE

JACKSCREW, CIRCLIP: STAINLESS STEEL

FINISH:

SIGNAL CONTACT:

CLIP = 0.3µ GOLD

SHELL = 3.5-5.0µ 100% TIN OVER NICKEL

POWER CONTACT:

BODY = GOLD

LATCHING COLLAR = NICKEL

COAX CONTACT:

BODY, SLEEVE, INNER CONTACT = GOLD

LATCHING COLLAR = NICKEL

ELECTRICAL:

WORKING VOLTAGE = 800V AC/DC

VOLTAGE PROOF = 1200V AC/DC

INSULATION RESISTANCE = 100MΩ MIN

SIGNAL CONTACT:

CURRENT RATING AT 25°C = 3.0A MAX

CURRENT RATING AT 85°C = 2.2A MAX

CONTACT RESISTANCE = 25 mΩ MAX

POWER CONTACT:

CONTACT RESISTANCE = 6 mΩ MAX

CURRENT RATING = 20A MAX WITH 12AWG

CONTACT AS SPECIFIED

COAX CONTACT:

FREQUENCY RANGE = 6GHz

IMPEDANCE = 50 Ω

V. S. W. R = 1.05 + (0.04 x FREQUENCY) GHz MAX

CONTACT RESISTANCE 6 mΩ MAX

INSULATION RESISTANCE = 10⁶MΩ @250V AC

OPERATING VOLTAGE = 180V AC @ 500mA

MAXIMUM VOLTAGE = 1000V AC

MECHANICAL:

DURABILITY = 500 OPERATIONS

SIGNAL CONTACT:

INSERTION FORCE = 2.0N MAX

WITHDRAWAL FORCE = 0.2N MIN

POWER & COAX CONTACT:

INSERTION FORCE = 8N MAX

WITHDRAWAL FORCE = 0.5N MIN

ENVIRONMENTAL:

TEMPERATURE RANGE = -55°C TO +125°C

PACKING:

BAG

FOR COMPLETE SPECIFICATION SEE COMPONENT SPECIFICATION C005XX (LATEST ISSUE)

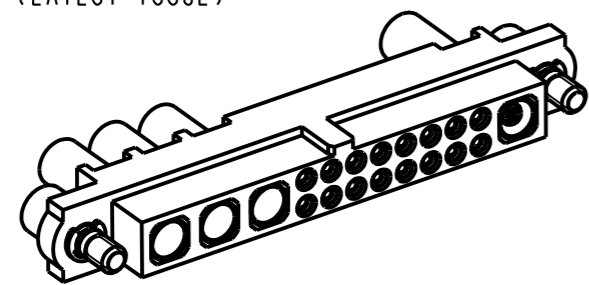
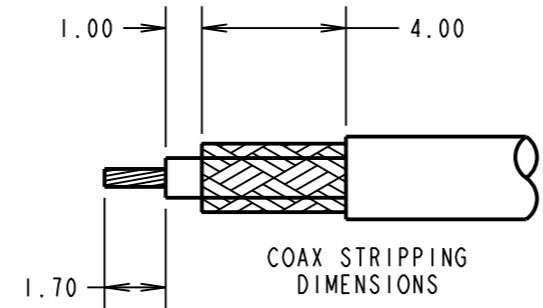
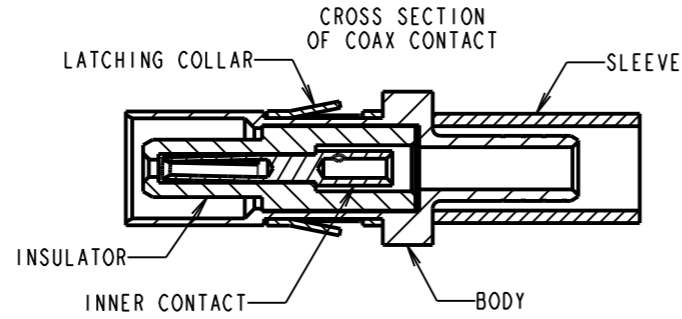
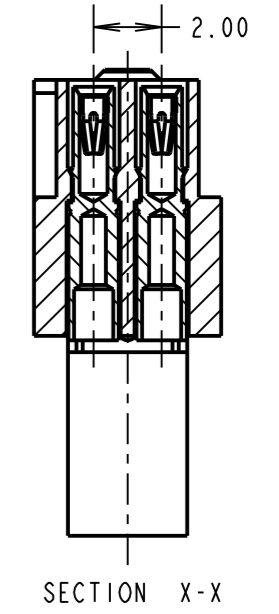
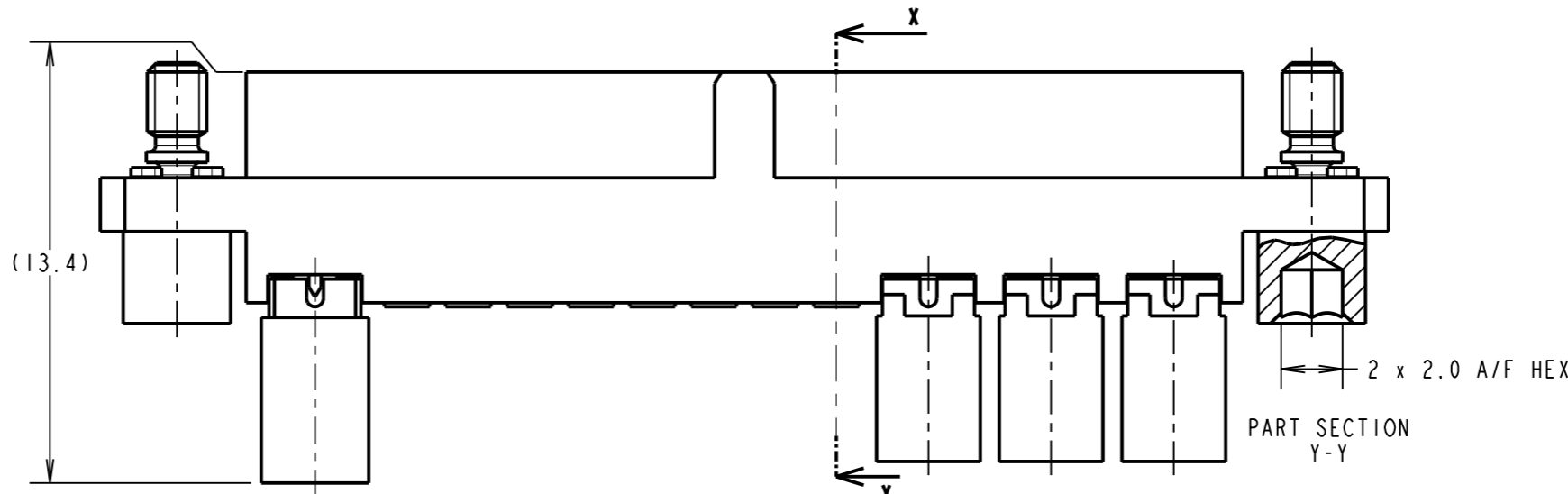
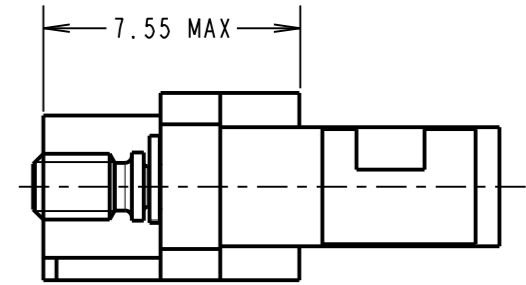
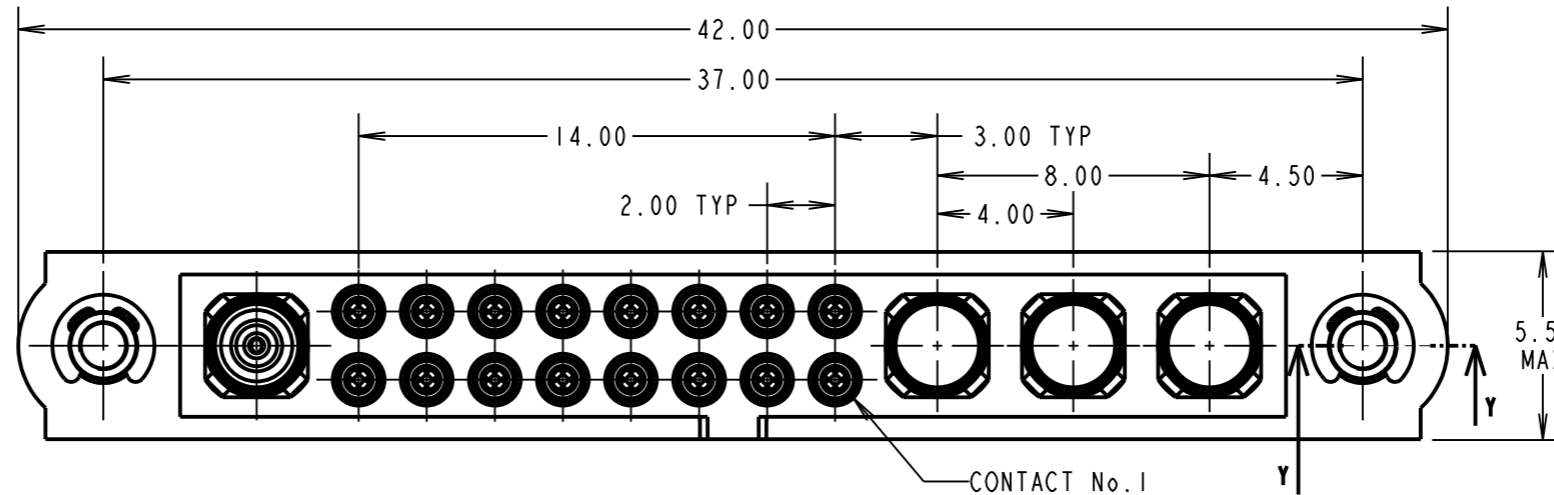

NOTES:

- CONNECTORS ARE SUPPLIED WITH CONTACTS LOOSE.
- FOR EXTRA SIGNAL CONTACTS, USE PART NUMBER M80-0130001.
- RECOMMENDED SIGNAL WIRE TYPE = BS 3G 210 TYPE A, PTFE INSULATED 24-28 AWG. MAX INSULATION DIAMETER = Ø1.10mm. STRIP WIRE BY 2.00MM FOR CRIMPING.
- RECOMMENDED HAND CRIMP TOOL FOR SIGNAL CONTACTS = M22520/2-01 WITH POSITIONER T5747.
- SIGNAL CONTACT INSERTION AND EXTRACTION TOOL = Z80-280.
- FOR EXTRA POWER CONTACTS, USE PART NUMBER M80-325.
- POWER CONTACT WIRE, STRIP BY 5.00mm MINIMUM.
- POWER & COAX CONTACT EXTRACTION TOOL = Z80-290.
- COAX CONTACT IS SUPPLIED AS A KIT OF PARTS: BODY, INSULATOR AND LATCHING COLLAR ARE PRE-ASSEMBLED AND SLEEVE AND INNER CONTACT ARE SEPARATE.
- FOR EXTRA COAX CONTACTS, USE PART NUMBER M80-307.
- RECOMMENDED HAND CRIMP TOOL FOR COAX INNER CONTACT = Z80-292 WITH POSITIONER Z80-291 AND RECOMMENDED HAND CRIMP TOOL AND DIE SET FOR COAX SLEEVE = Z80-293.
- INSTRUCTION SHEETS ARE AVAILABLE.

MGP	1	11.04.16	----
NAME	ISS.	DATE	C/NOTE
APPROVED: MGP			
CHECKED: MS			
DRAWN: M.G.PLESTED			
CUSTOMER REF.:			
ASSEMBLY DRG:			

HARWIN
www.harwin.com
technical@harwin.com

THIS DRAWING AND ANY INFORMATION OR DESCRIPTIVE MATTER SET OUT HEREON ARE CONFIDENTIAL AND COPYRIGHT PROPERTY OF THE HARWIN GROUP AND MUST NOT BE DISCLOSED, LOANED, COPIED OR USED FOR MANUFACTURING, TENDERING OR FOR ANY OTHER PURPOSE WITHOUT THEIR WRITTEN PERMISSION.

TOLERANCES
X. = ±1mm
X.X = ±0.50mm
X.XX = ±0.10mm
X.XXX = ±0.01mm
ANGLES = ±5°
UNLESS STATED

MATERIAL:
SEE ABOVE
FINISH: SEE ABOVE
S/AREA: mm²

TITLE: JACKSCREW DATAMATE MIXED TECHNOLOGY CRIMP FEMALE ASSEMBLY
DRAWING NUMBER: M80-4C11642F2-03-325-01-307
SHT 2 OF 2